

LabTIE Bead Dispenser

ACCURATE MODULAR BEAD DISPENSER

Simple. Fast. Reliable

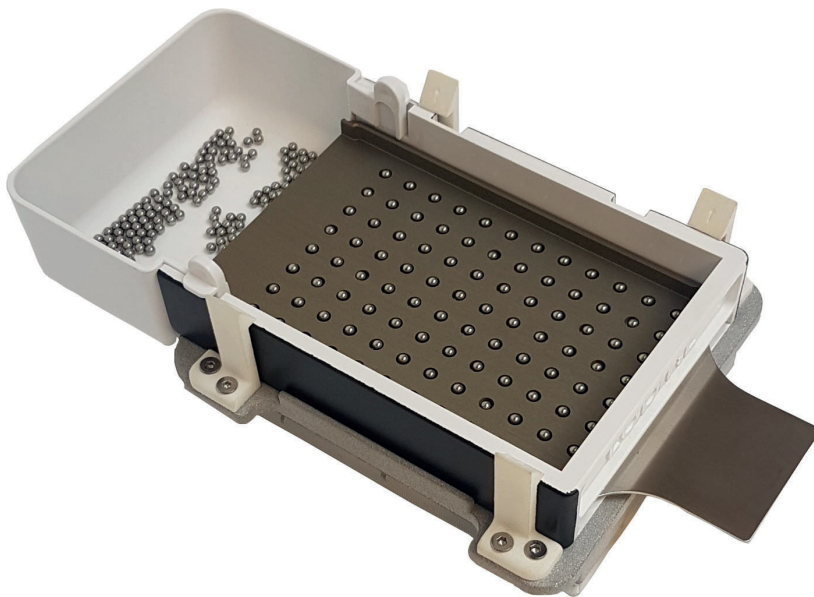

LabTIE Bead Dispenser

The LabTIE Bead Dispenser ensures fast and accurate dispensing for all types of beads. Due to its modular design of exchangeable Mesh plates the dispenser can dispense a variety of sizes and amounts.

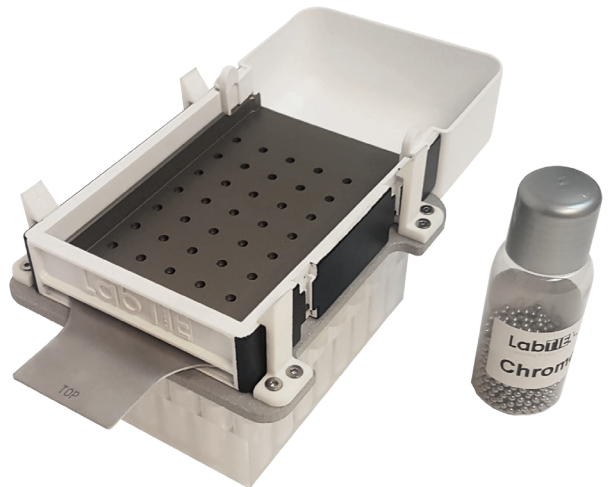

FIND THE RIGHT FIT FOR YOU

- Custom made mesh plates for your beads of choice
- Exchangeable mesh plates to maximize flexibility
- Wide variety of container type, such as tubes, microtiter plates, vials etc.
- Available in 5 types of grid:
 - 24
 - 45
 - 48
 - 96
 - 384

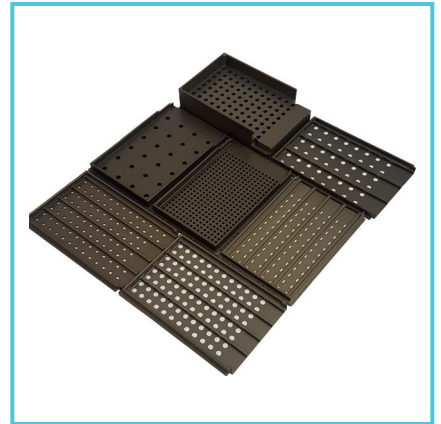

EASY TO USE

- Simple change of mesh plates from the Bead Dispenser between applications
- User-friendly dispensing by pulling the slider
- Easy to clean

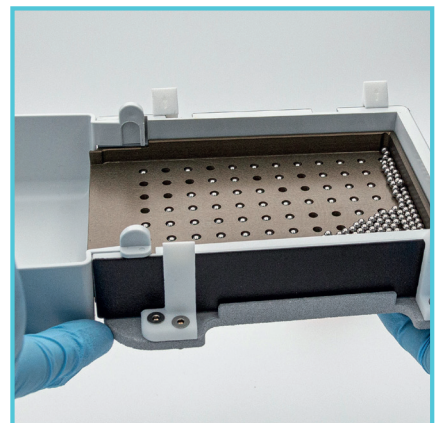

INCREASE YOUR ACCURACY

- Accurate dispensing, < 1% error rate
- Dispenses beads with sizes from 0.3mm to 6.0mm accurately
- The required amount per well is dropped in your designated grid



FAST AND RELIABLE

- Dispensing in only 30 seconds
- Anodized aluminum mesh plate with anti-static properties to minimize interaction with your input material
- Designed, produced and tested by our own Tech Division



LabTIE Bead Dispenser

Product Dimensions

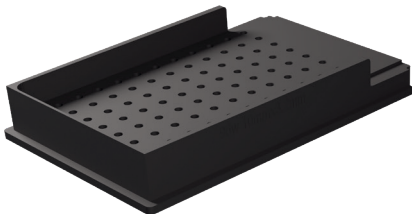

MESHPLATE

- L: 130 mm
- W: 87 mm
- H: 10/15/20/25 mm

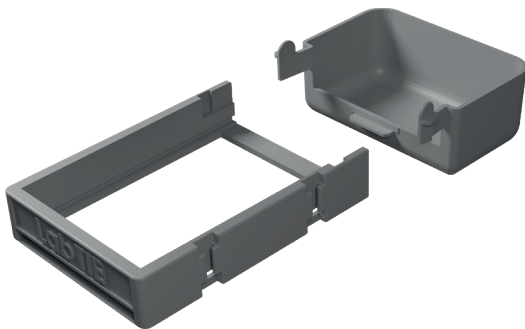

MAIN UNIT + BUCKET

- L: 185 mm
- W: 90 mm
- H: 40 mm

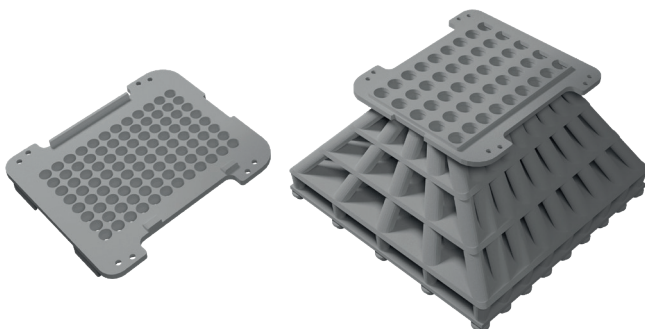

CONVERTER

- Flat or funnel shaped
- Varying sizes depending on designated grid

LabTIE Bead Dispenser

Product Composition

Mesh plate	Anodized Aluminum 6082
Bucket	Polycarbonate 90% - Acrylamide 10%
Main Unit	Polycarbonate 90% - Acrylamide 10%
Slider	RVS 316
Clamp/Finger	Nylon
Bolt and nut	RVS 304
Converter	Aluminum/Nylon composition



LabTIE Bead Dispenser

Grid Compatibility Information

Plates	96-well Microtiter, Cell culture, Deep-well plates, plates with strips
	384-Well Microtiter and deep-well plates
	24-well Microtiter and deep-well plates
	48-well Microtiter and deep-well plates
Tubes	Snap cube tube 0.2mL - 1.5mL
	Screw cap tube 1.5 mL - 2.0 mL
	Cryo tube 1.5 mL - 2.0 mL

Product information



Product name	Reference
LabTIE Bead Dispenser	Contact our sales rep. for reference